

A New Form of Major Cutting Edge of Helical Drill

PhD. Eng. DIMA M., Eng. BERBINSCHI S.,
Eng. DUMITRAȘCU N., PhD. Eng Oancea N.
University "Dunărea de Jos", Galați, Romania

ABSTRACT

In this paper, it's analyzed a new method of building crooked cutting edges for helical drills, through decreasing of the size of rake angle from working plane.

It's proposed an analytical modelling and, therewith, a 3D modelling of rake angle sizes along cutting edge, through accomplishment of a new building form of helical drill main cutting edge.

Keywords: helical drills, cutting, 3D modelling.

1. Introduction

A problematically apart to geometry of helical drills, towards with distinct works with such as tools, enforced multiple constructive modifications, in aim uniformity conditions for forming and detaching chips to longwise major cutting edge, following:

- a better geometry in zone of chisel edge [1],[3],[8];
- an uniform loading power to longwise major cutting edge [6],[7],[8];
- the geometrical modification of edge with the aim improvement formation chip to longwise cutting edge [2],[5],[7] (a tool rake with an uniform variation of this size);
- the decrease of the force and the moment of removal chip [1],[4], an easy carry off chips [5].

It is difficult reunion all conditions in sight to establishment the optimum geometries of helical drill, but, an ensemble of requirements above-mentioned can bring to improvement of thus operation tools.

In paper, is make an analysis of variation size of tool rake longwise major cutting edge, following uniformity loading power, through to utilization rounded cutting edge and diminution to variation size of tool rake longwise to major cutting edge of helical drill.

2. The tool rack longwise to major cutting edge

The tool rack angle longwise to major cutting edge of drills has an important variation,

decreasing from periphery to axis drill, relative easy situation of gained the obvious in if is considered the tool rake angle from the working plane (parallel plane with axis drill), figure 1 (working plane, P_f).

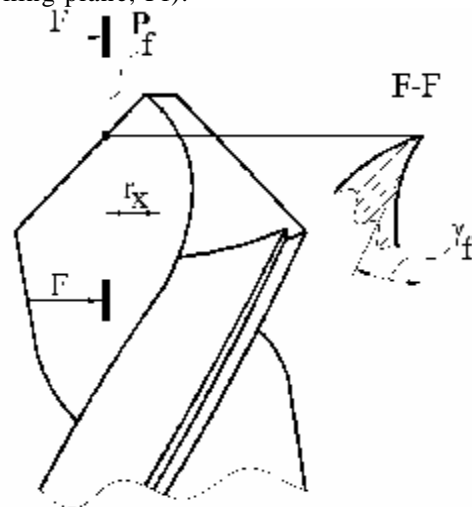

Fig. 1. The tool rake angle from working plane, P_f

It is obvious as with the enlargement size of radius r_x to selected point on the cutting edge of drill, the angle γ_f increase in absolute value.

This particular situation to all inside tools with helical channels, particulars to drills, leads to modification of conditions for forming of chip and, by default, towards non-uniform behavior of process formation chip longwise cutting edge.

The uniformity of size to rake angle longwise cutting edge of drill can constitute a

path for improvement this behavior lot of tool in formation process of chip.

Therewith, must direct to another important considerations such as: an assurance uniform loading power in longwise cutting edge - convenient geometry of chisel edge of the tool.

Is proposed, one what in the trace, a comparative study, analytically and 3D modeling through connected with variation of size tool rake γ_f longwise major cutting edge, for tool with rounded cutting edge, with rounded cutting edge radius [2], [9], see figure 2.

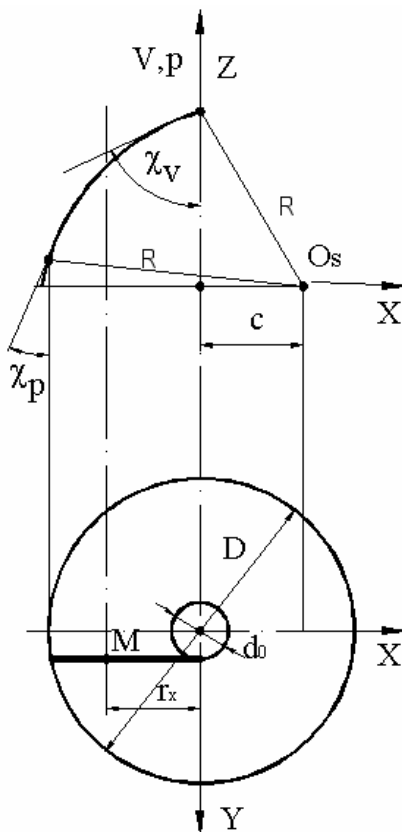

Fig. 2 The major cutting edge (D - exterior diameter of drill, d_0 - diameter of core)

In the reference system joint drill axis, XYZ, the parametric equations of cutting edge there are:

$$\begin{aligned} X &= -c + R \cos q; \\ Y &= \frac{d_0}{2}; \\ Z &= R \sin q. \end{aligned} \quad (1)$$

In (1), it's defined: θ is an angle variable;

$$R = \frac{\sqrt{\frac{D^2}{4} - \frac{d_0^2}{4}}}{\cos C_p - \cos C_v}, \quad (2)$$

the size of radius to rounded cutting edge or plane cutting edge;

$$c = R \cos C_v, \text{ geometrical condition } (3)$$

χ_p and χ_v - working cutting edge angle to corner and periphery of tool.

The helical surface to face of tool, of axis \vec{V} and helical parameter p, has equations:

$$\begin{aligned} x &= [-c + R \cos q] \cos j - \frac{d_0}{2} \sin j; \\ y &= [-c + R \cos q] \sin j + \frac{d_0}{2} \cos j; \\ z &= R \sin q + pj, \end{aligned} \quad (4)$$

with φ variable angular parameter, and

$$p - \text{helical parameter, } p = \frac{D}{2 \cdot \text{tg} \omega}$$

ω - angle inclination of exterior screw (accordant with diameter of drill, D)

It is defined the tool rake angle in a parallel plane with axis drill (working plane, P_f),

$$P_f : x = r_x, (r_x - \text{variable distance}) \quad (5)$$

and

$$0 \leq r_x \leq \sqrt{\frac{D^2}{4} - \frac{d_0^2}{4}}. \quad (6)$$

see figure 2.

The definition encountered (5) is someway relative, but don't influences about qualitative conclusions of considered problem.

From (4) and (6), results condition of intersection

$$\left| [-c + R \cos q] \cos j - \frac{d_0}{2} \sin j - r_x \right| \leq q \quad (7)$$

which in, q is little positive as order of size (for example, $q = 1 \cdot 10^{-3}$).

The ensemble of the equations (4) and (7) represents the form to the intersection edge of the rake surface with the measurement plane, P_f .

In principle, the tool rake in working plane, P_f , corresponding distance r_x , see figure 3, P_{f, r_x} , is defined between tangent to edge of intersection surface of channel with plane P_{f, r_x} and direction of axis drill.

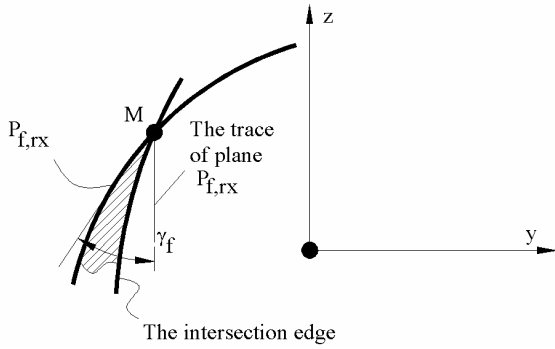

Fig. 3. The tool rake, γ_f , from working plane, $P_{f,rx}$

In figure 4, is presented the variation of the tool rake, γ_f , longwise to cutting edge for drill with rounded cutting edges, for a concrete cases, $D = 20 \text{ mm}$, $\omega = 30^\circ$.

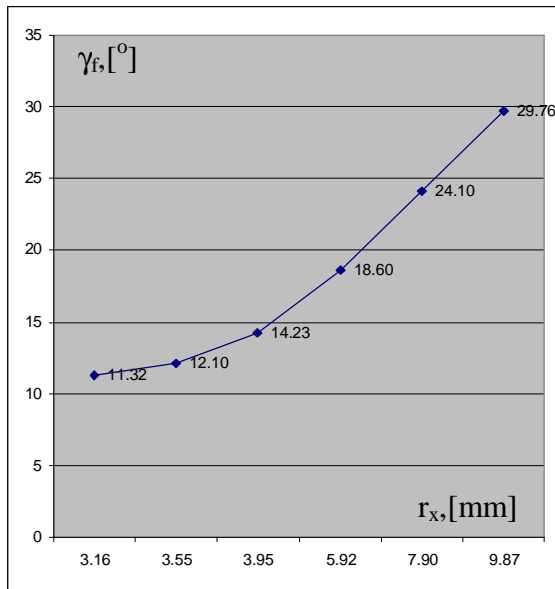

Fig. 4. The variation of the tool rack, γ_f

It's obvious an ascending the variation of the angle γ_f to periphery of drill and, therefore, a solution of level his size imposes, directing to requirement enounce.

Is proposed an analysis of geometry for major cutting edge of drill, connected with variation of the angle γ_n longwise to cutting edge, by 3D solid modeling.

In 3D model of face, it's presented the working plane, P_f , see figure 5.

The plane, P_n , is defined as normal plane, in selected point, on the cutting edge.

The tool rake angle, γ_n , is defined in a normal plane to cutting edge, P_n , between the tangent to intersection curve of edge with tool face (the helical channel) and the base plane for even selected point (this plane contains the drill axis and the selected point M on cutting edge).

Through modification of position to selected point on the cutting edge, it's modeled the size of tool rake angle in normal plane, P_n , different in points longwise to major cutting edge, for tool with curvilinear cutting edge - a circle, contact tangent plane to core cylinder of drill ($\lambda^* = 0$).

Is proposed a modification to form of the major cutting edge of the drill, through modification to position of the cutting edge plane, for same curved form of major cutting edge, figure 5, considering as the plane of cutting edge form with tool axis an angle λ^* , figure 5. In this case, it's necessary to change the form of the tool for generation of helical channel.

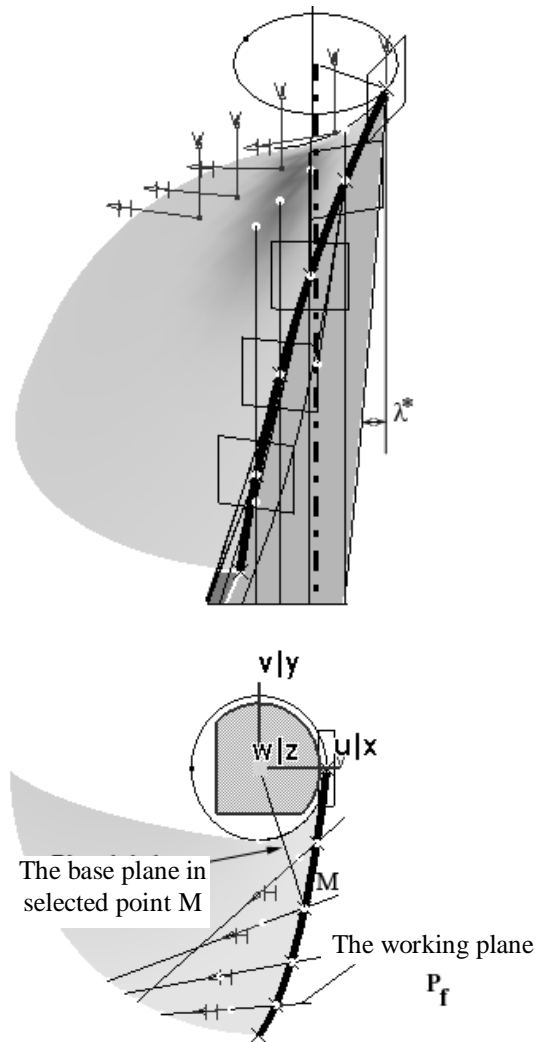

Fig. 5. The form of the cutting edge; the plane of the cutting edge inclination with angle, λ^* .

In figure 6 and table 1, it's definite, by 3D modeling of the face surfaces and the normal plane, P_n , the law to variation size of tool rake angle longwise the major cutting edge, for different sizes of angle to the cutting edge plane, λ^* .

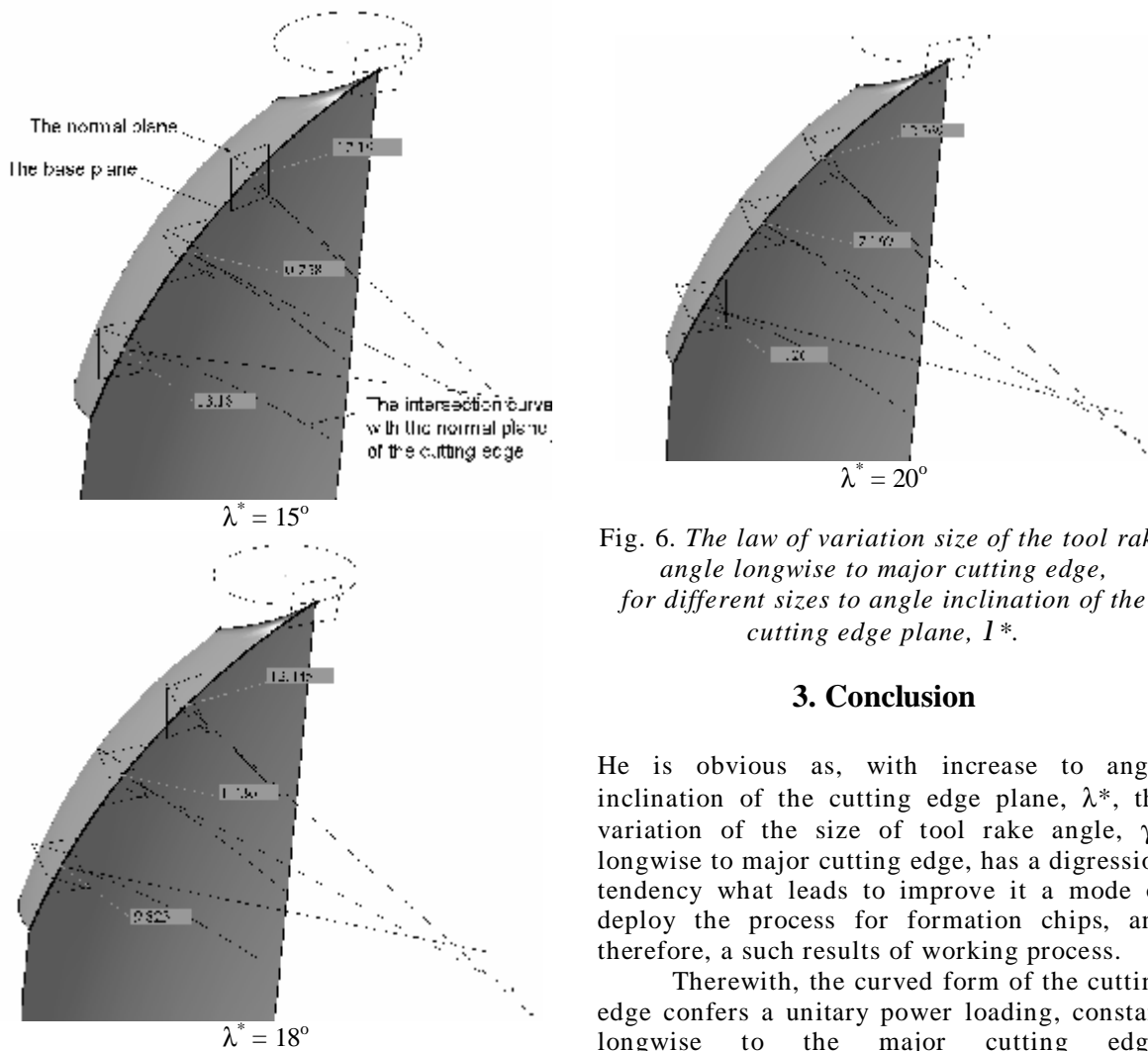
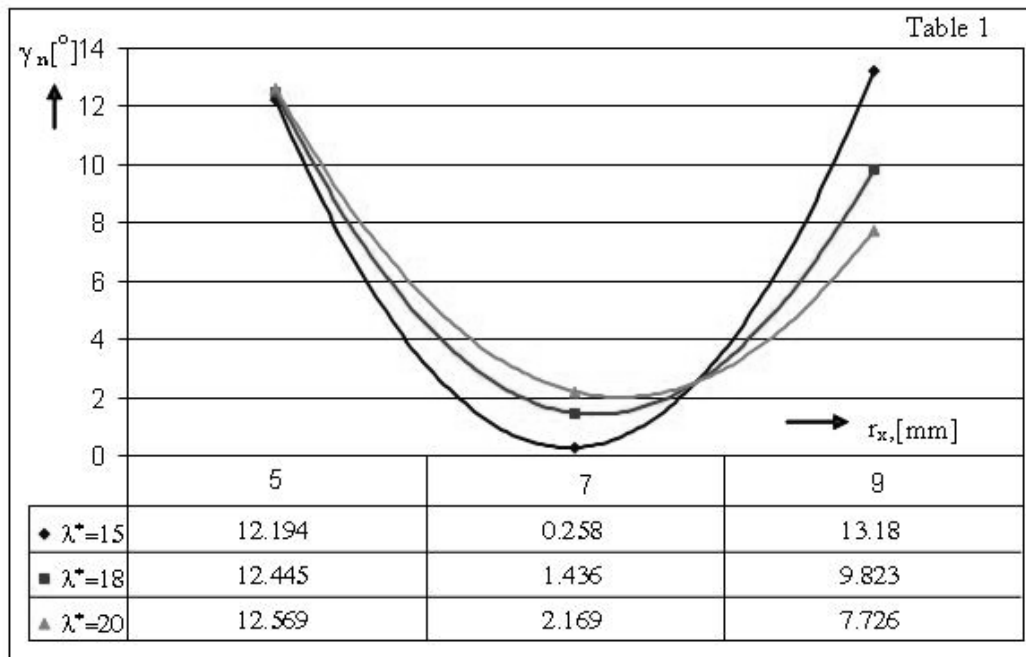

Fig. 6. The law of variation size of the tool rake angle longwise to major cutting edge, for different sizes to angle inclination of the cutting edge plane, λ^* .

3. Conclusion

He is obvious as, with increase to angle inclination of the cutting edge plane, λ^* , the variation of the size of tool rake angle, γ_n , longwise to major cutting edge, has a digression tendency what leads to improve it a mode of deploy the process for formation chips, and therefore, a such results of working process.

Therewith, the curved form of the cutting edge confers a unitary power loading, constant longwise to the major cutting edge,

accomplishing second requirement enforced to cutting edge.

Moreover, the form the cutting edge, insures an angle of inclination, λ , favorably, in longwise to the cutting edge, contributing to improvement behavior of this tool to solicitations with shocks during cutting process.

References

1. **Anish P., Shiv G. Kapoor, Richard E. Devor,** *Chisel edge and cutting lip shape optimization for improved twist drill point design*, International Journal of Machine Tools & Manufacture, 45, 421-431, 2004.
2. **Hsieh J.-F., Lin P. D.,** *Drill point geometry of multi-flute drills*, International Journal of Advanced Manufacturing Technology, 26, 466-476, 2005.
3. **Hsieh J.-F.,** *Mathematical model for helical drill point*, International Journal of Machine Tools & Manufacture, 45, 967-977, 2005.
4. **Kang D., Armarego E. J. A.,** *Computer – Aided Geometrical Analysis of the Fluting Operation for Twist Drill Design and Production. II. Backward Analysis, Wheel Profile and Simulation Studies*, Machining Science and Technology, 7, 2, 249-266, 2003.
5. **Mellinger J. C., Ozdoganlar O. B., DeVor R. E., Kapoor S. G.,** *Modeling Chip-Evacuation Forces in Drilling for Various Flute Geometries*, Journal of Manufacturing Science and Engineering, 125, 405-415, 2003.
6. **Mihailide M., Croitoru I., Cozmîncă M.,** *Scule aşchietoare. Concepție, proiectare, utilizare*, Editura Tehnica-Info, Chişinău, 2002.
7. **Minciu C., Croitoru S. M., Bălan E.,** *Proiectarea sculelor aşchietoare*, Editura BREN Prod. 32, Bucureşti, 1999.
8. **Belous V.,** *Sinteza sculelor aşchietoare*. Editura Junimea, Iaşi, 1980.
9. **Plăhteanu B., Cozmîncă M.,** *Contributo alla studio del tornio con la parte tornitrice rotativa*, Revista de Ingineria, Milano, 1971, p. 28-34.
10. **Fetecău C., s.a.,** *Burghie cu durabilitate ridicată*, Editura Tehnică, Bucureşti, ISBN 973-31-12410.

Une nouvelle forme pour le tranchant du foret hélicoïdal

Résumé

En ce document, on présente une nouvelle méthode pour l'amélioration de la forme constructive au tranchant pour les forets hélicoïdaux avec les tranchants courbes, par la diminution la taille de l'angle de coupe dans plane du travail. Il a proposé une modélisation analytique et, en conséquence, un modèle 3D du tranchant.

O noua formă a muchiei de aşchiere principală a burghiului elicoidal

Rezumat

În lucrare, se analizează o nouă modalitate de îmbunătățire a formei constructive a muchiei de aşchiere a burghiilor elicoidale cu tăişuri curbe, prin diminuarea mărimii unghiului de degajare din planul de lucru. Se propune o modelare analitică și, totodată, 3D, a mărimii unghiului de degajare în lungul tăişului, precum și, o nouă formă constructivă a muchiei de aşchiere principale a burghiului elicoidal.